

Data Sheet



Article number: 0108057

Description: Retaining ring JK 40 DIN 984

Measures

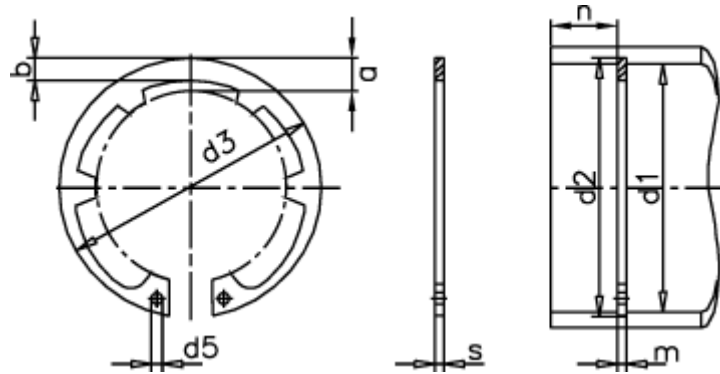

a max	= 7.2	FN kN	= 27.0	s	= 1.75
AN mm ²	= 162.0	FRg kN	= 8.3	t	= 1.25
b	= 4.0	FR kN	= 44.6	tol	= +0,25
d1	= 40	g	= 2.0	tol	= -0.06
d2	= 42.5	K kN-mm	= 80.1	tol	= +0,90-0,39
d3	= 43.5	m min	= 1.85	Tong	= ZGJ-3
d5 min	= 2.5	Nominal drive	= 3.8	Weight kg/1000	= 5.30
Description	= JK 40	Number of serrations	= 6		